

- Noncorrosive polyethylene tank
- Convenient carrying handle with wand storage clip
- Automatic relief valve keeps tank at safe pressure and shows correct operating range
- Noncorrosive polypropylene pump
- Nozzle adjusts from mist to stream spray
- Thumb-control discharge for accurate spraying

EXCLUSIVE FEATURES

SPRAY DOC® owner's guide

SPRAY DOC® owner's guide

EXCLUSIVE FEATURES

- Noncorrosive polyethylene tank
- Convenient carrying handle with wand storage clip
- Automatic relief valve keeps tank at safe pressure and shows correct operating range
- Noncorrosive polypropylene pump
- Nozzle adjusts from mist to stream spray
- Thumb-control discharge for accurate spraying



OWNER'S GUIDE

NON-CORROSIVE, POLYETHYLENE, COMPRESSED AIR SPRAYER

PLEASE READ AND FOLLOW ALL INSTRUCTIONS BEFORE USING SPRAYER

WARNING

Always inspect your sprayer thoroughly before each use. Be sure hose is securely attached and in good condition before pressurizing tank. Test with water at beginning of each season.

Always follow directions on spray material containers. Read them thoroughly and follow carefully.

Always wear such protective clothing (goggles, face masks, long sleeves, long pants, gloves, etc.) when spraying as is recommended by the manufacturer of the spray material. Do not allow spray to reach people or animals.

Always release air pressure before removing pump or servicing sprayer in any way by pulling pressure relief valve knob out fully.

Do not use flammable materials in this sprayer, as this could cause the sprayer to explode.

Do not use caustic, acidic, or corrosive material in this sprayer, as they could weaken and corrode the parts which could lead to injury.

Do not use mechanical devices to pressurize the tank. They can create excessive and dangerous pressure which could cause the tank to explode.

Do not stand over pressurized tank while using or pumping it.

Always securely tighten the pump. An improperly tightened pump could be forcibly ejected and cause serious injury.

Do not use solutions hotter than 105°F.

Do not damage or alter the function of the pressure release valve or plug the pressure relief valve hole, as this could cause the sprayer to explode.

Do not pressurize sprayer until ready to use. Do not leave pressurized sprayer unattended.

Do not lift or carry sprayer by hose or extension rod.

Clean tank and valve thoroughly with soap and water after herbicides and other poisons have been used.

If nozzle clogs, do not force open with air pressure. Remove nozzle and clean with fine wire or toothpick.

Read and follow all instructions in sprayer manual before using sprayer.

FAILURE TO HEED ALL SAFETY INSTRUCTIONS AND WARNINGS COULD RESULT IN SERIOUS BODILY INJURY.

HOW TO PREPARE YOUR SPRAYER FOR USE

1. Assemble extension rod to valve by inserting and holding rod into open end of valve. Attach extension cap securely by hand. **NOTE: Never use tools to tighten connection nuts.**
2. Remove pump and cap assembly.
3. Mix spray solution in separate receptacle, following directions on spray solution container.
4. Strain solution through fine cheesecloth or household strainer to remove particles that could clog nozzle.
5. Use any amount of liquid up to the "Fill-To-Here" mark. **DO NOT** fill beyond this line.
6. Replace pump and cap assembly and tighten securely.
7. If sprayer has been stored, manually operate pressure relief valve by pulling knob out and pushing back in fully several times.
8. Pressurize tank by pumping approximately 10-20 times (depending upon amount of liquid used).^{*} If a hissing sound through pressure relief valve is detected, sprayer is overpressurized. Quit pumping. Leave tank on a level surface until hissing stops. ^{*}As tank becomes pressurized, the knob of the pressure relief valve and gage will extend exposing a color band. This band indicates the sprayer pressure operating range. (See Figures 1 and 2 on next page.)

HOW TO USE YOUR SPRAYER

1. Adjust nozzle cap. Tighten cap for fine spray or loosen for coarser spray or solid stream. **WARNING:** Loosening cap too far will result in cap flying off, allowing spray material to spray back at you.
2. Pump occasionally to maintain tank pressure and desired spray pattern. Pump when color band no longer shows.
3. The extension rod can be rotated 360°, turning counter-clockwise with extension rod pointed away from you.
4. Attach extension rod to handle by pushing it into the two clips provided.
5. Sprayer should only be carried by top of handle or strap (if provided). Never carry tank by the hose, discharge rod or pump handle.

CLEANING AND MAINTENANCE INSTRUCTIONS

NOTE: A small amount of care will repay you in long life and efficient operation.

1. **RELEASE AIR PRESSURE** by pulling knob of pressure relief valve. Pull out fully and allow all air to escape. (See Figure 3).
2. Loosen cap slowly. Remove pump and cap assembly. Pour out any remaining spray solution and rinse all parts thoroughly with clean water.
3. Leaving a small amount of clean water in tank, pressurize and flush discharge equipment by depressing trigger approximately 30 seconds.
4. **RELEASE AIR PRESSURE** by pulling knob of pressure relief valve; remove cap and pump assembly. Rinse tank again and empty water.
5. To clean nozzle cap, refer to nozzle maintenance section.
6. Pull pressure relief valve knob out fully and rotate 90° to safety lock position. Tank cannot be pressurized with valve in this position.
7. Always store tank empty and with tank cap loose, upside down.
8. Apply approximately 10 drops of 20 weight or heavier motor oil in opening provided at top of tank cap before each growing season use and periodically thereafter.
9. If trigger is sluggish, remove extension rod assembly, depress trigger and apply 5 drops of oil in end of valve head.

PRESSURE RELIEF VALVE FUNCTION

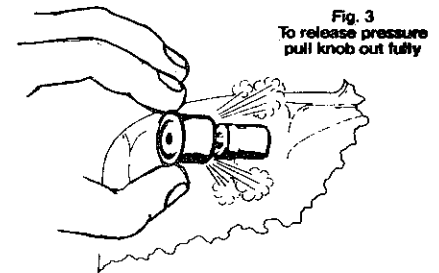
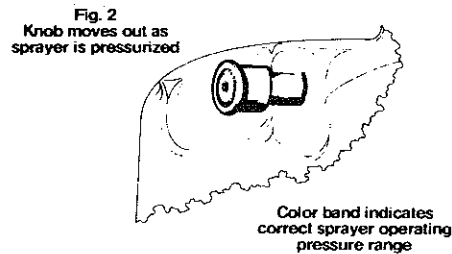
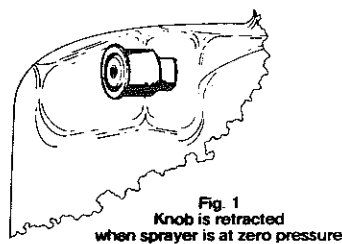

TROUBLE SHOOTING YOUR PLASTIC SPRAYER

PROBLEM: Sprayer Fails To Pressurize.

Step 1. Be sure tank cap is tight.

Step 2. Check to see if pressure relief valve is in safety lock position.

Step 3. Oil pump cup.

- Lift pump plunger and apply approximately 10 drops of 20 weight or heavier motor oil in hole provided in top of tank cap.(A)
- Work plunger up and down.
- If sprayer will not pressurize, proceed to Step 4.

Step 4. Check pump assembly. SEE FIG. 4

- **RELEASE AIR PRESSURE.**
- Remove pump and tank cap assembly.
- Remove pump plunger by holding pump cylinder (B) firmly and pushing tank cap (A) up with thumbs to remove.
- Inspect cylinder gasket (D). If soiled, clean all surfaces of gasket and rim of tank with clean lint-free cloth. If split or worn, replace using parts from repair kit (refer to back page for part number).
- With pump still disassembled, inspect pump cup (E) for damage. If in good condition, wipe off any foreign particles. If damaged, replace using parts from repair kit (refer to back page). Oil with 20 weight or heavier motor oil.
- Inspect check valve (F). If soiled, clean with lint-free cloth. If worn or split, replace using parts from Kit (refer to back page).
- Reassemble by starting plunger into pump cylinder at an angle. Replace cylinder into tank and tighten tank cap until cylinder and cap "snap" together and are tight.
- Oil pump cup following instructions in Step 3.
- If tank fails to retain pressure, proceed to the next sections to check for leaks.

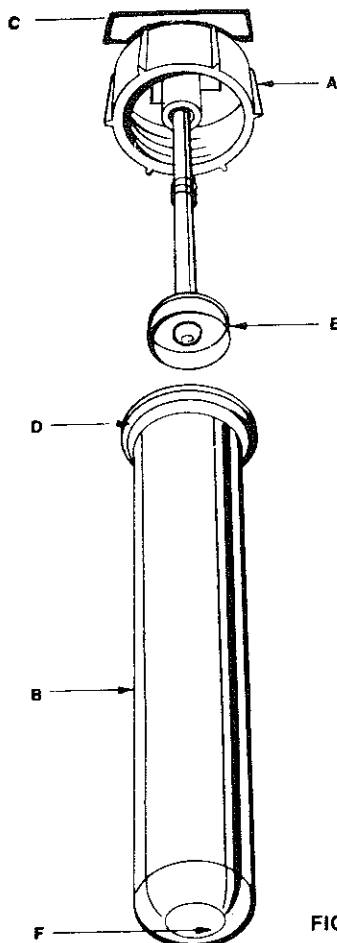

FIG. 4

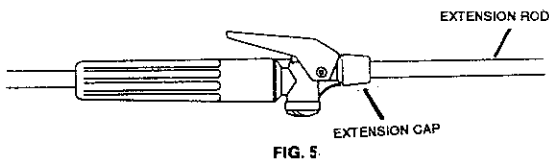

FIG. 5

PROBLEM: Sprayer Leaks. SEE FIG. 5

Step 1. Extension cap at extension rod.

- Tighten extension cap securely by hand.
- If leak persists. **RELEASE AIR PRESSURE**, remove rod by loosening extension cap and pulling rod straight out.
- If connection surfaces are scratched or damaged, replace using parts from Kit R-15C (refer to back page)

POSITION CLAMP AWAY FROM HOSE END AND CLOSE TO THIS RAISED SURFACE.

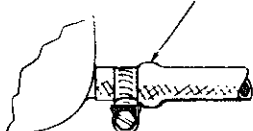

FIG. 6

Step 2. Hose at tank. SEE FIG 6.

- Release air pressure.
- Inspect hose, if split or worn, replace with parts from Kit (see back page).
- (NOTE: DO NOT ATTEMPT TO REUSE ORIGINAL FACTORY INSTALLED CRIMPED CLAMP).
- (a) Slide clamp on hose.
- (b) Holding end of hose under hot water for approximately 3 minutes will allow hose to slide on tank outlet easier.
- (c) Push hose fully onto tank outlet.
- (d) Slide clamp into position shown in FIG. 6.
- (e) Tighten clamp until a snug fit is obtained.
- Test for leakage by pressurizing with plain water.
- If leak persists tighten clamp until it stops.

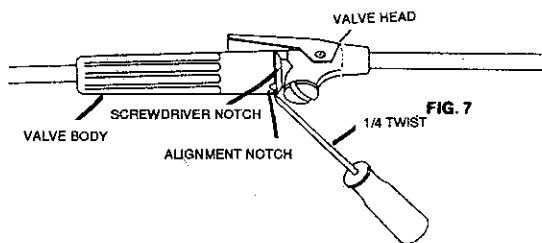

FIG. 7

Step 3. Where hose enters valve body

- Insert small blade screw driver into notch and twist 1/4 turn to separate valve body from valve head. SEE FIG. 7
- Slide valve body back along hose to expose connection of hose with valve head. SEE FIG. 8
- Plastic sleeve must be tight on hose, if not grip sleeve firmly with thumb and forefinger and push toward end of hose until snug.
- If leakage is due to cracked or damaged hose, cut off behind sleeve, remove sleeve with pliers as shown then cut remaining hose off valve head hose fitting. SEE FIG. 9
- To reassemble.
 - (a) Slide plastic sleeve over hose (larger end of tapered sleeve toward end of hose.) SEE FIG. 8
 - (b) Push hose fully on valve head fitting (soaking end of hose in hot water first will make this operation much easier.)
 - (c) Push sleeve snugly on hose as described above.
 - (d) Align valve body with valve head and snap together tightly. SEE FIG. 7

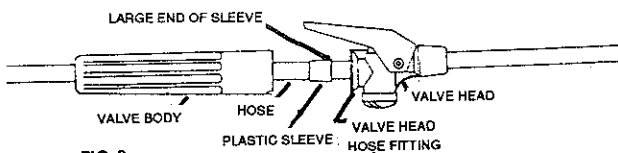

FIG. 8

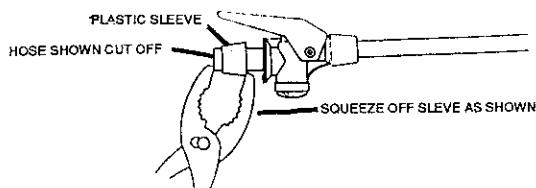

FIG. 9

Step 4. If leak is from any other area of valve, replace valve assembly using Kit (see back for part number).

PROBLEM: Sprayer Nozzle Does Not Spray or is missing.

Step 1. Clean nozzle.

- **RELEASE AIR PRESSURE.**
- Remove nozzle cap.
- Clean nozzle body (A) and cap orifice (B) using a toothpick or broom straw.
- Replace nozzle.

Step 2. Install new nozzle cap.

- If damaged or lost, replace using parts listed on back page. (refer to back page).

SPRAYER NOZZLE MAINTENANCE

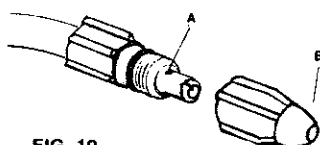

FIG. 10

REPAIR KITS for ALL PLASTIC SPRAYER MODELS

KIT No. R-30C (1 1/3, 2, 3, GAL.)
 Brass Nozzle Cap
 Cylinder Gasket for Plastic Pump
 Pump Cup
 Check Valve
 O-Ring (Nozzle)
 Cylinder Gasket for Steel Pump
 Expander

KIT R11C (1 1/3, 2, 3, GAL.)
 Cylinder Gasket for Plastic Pump
 Pump Cup
 Check Valve
 Cylinder Gasket for Steel Pump
 Expander

KIT R-58C (1 1/3, 2, 3, GAL.)
 Complete Valve Assembly

KIT R-66C (ALL MODELS)
 Body
 Stem Assembly
 Spring
 Cap
 Sleeve
 Knob

KIT R-10C (POLY NOZZLE (101P76))
 Brass Nozzle Cap
 O-Ring

KIT R-15C (6" WAND 051P76)
 Complete 16" Poly Extension
 Rod Assembly

KIT R-51C (1 1/3, 2, 3, GAL.)
 Hose & Clamps

KIT R-21B (FOR 2/3 GAL.)
 Pump Seals

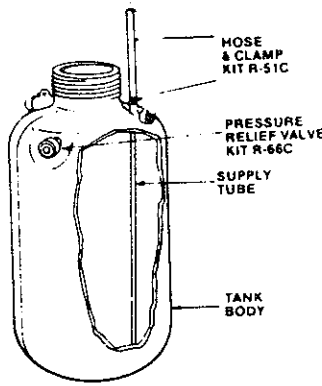

COMPLETE PUMP ASSEMBLY

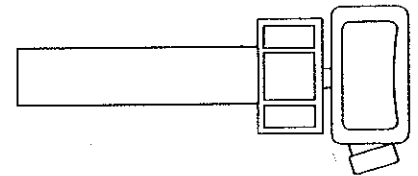

PUMP CYLINDER ASSEMBLY

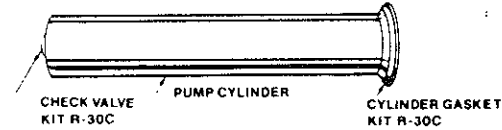

PUMP PLUNGER ASSEMBLY

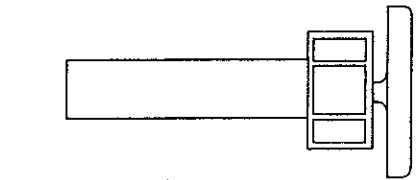
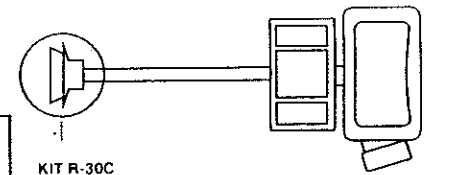

FOR 2/3 GAL. MODEL

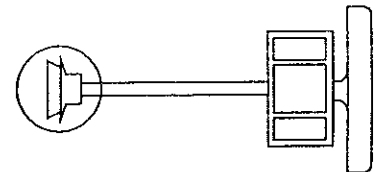

POLYETHYLENE TANK SPRAYERS Parts List

Part Name

	1 1/3 Gal. Model	2 Gal. Model	3 Gal. Model
Tank Body	W101P20R	W201P20R	301P20R
Supply Tube	101P24B	201P24B	301P24B
Complete Pump Assembly	100075GN	100075GN	100075GN
Pump Handle Assembly	100074GN	100074GN	100074GN
Pump Cylinder Assembly	100081	100081	100081
Strap	-----	-----	300050
Complete Poly Ext. Rod	101P76	101P76	101P76
Poly Nozzle Cap	101P16	101P16	101P16
Hose	R51C	R51C	R51C
Complete Valve Assembly	R58C	R58C	R58C
Pump Repair Kit	R11C	R11C	R11C
Clamp	10031HD	10031HD	10031HD

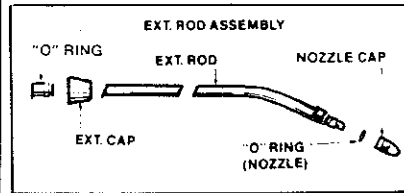

COMPLETE VALVE ASSEMBLY
 KIT R-58C (1 1/3, 2, 3, GAL.)
 051P73K (2/3 GAL.)

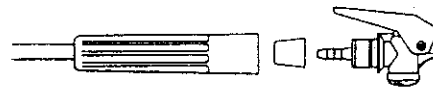

GENERAL SPRAYING HINTS

1. Mix spray solution as directed on container.
2. Spray in the cool of the day, never when wind is blowing.
3. Dress right . . . cover arms, legs and wear eye protection.

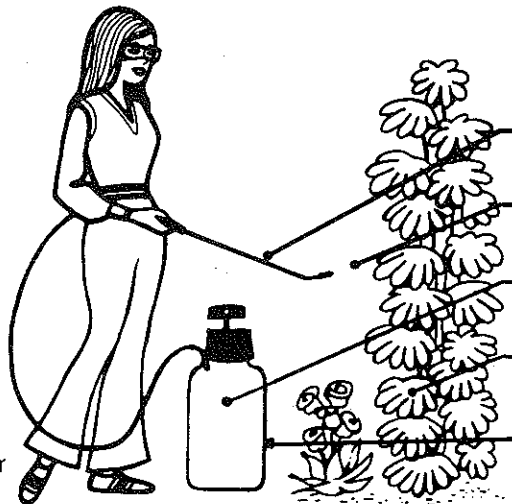

SPRAYING TIPS

- Spray all around to catch trouble wherever it may start.
- Fine spray for flowers. Medium for shrubs and bushes. Coarse spray for weeds.
- High pressure for fine spray, lower for medium and coarse.
- Over spraying is harmful and wastes expensive material.
- Always be sure to wash and rinse your sprayer after each time it is used.



A SUBSIDIARY OF VERMONT AMERICAN CORPORATION

Gilmour Manufacturing Company
 P.O. Box 838, Somerset, Pennsylvania 15501-0838
 Parts Department
 (800) 852-2723
 Customer Service
 (800) 458-0107 (814) 443-4802

Made and Printed in U.S.A.

N101P60